

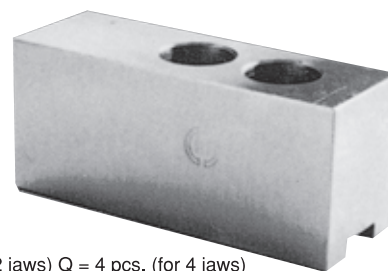

CHUCK

Soft Jaws for Power Chuck

SB series



Description of Model **SB06A1-80**

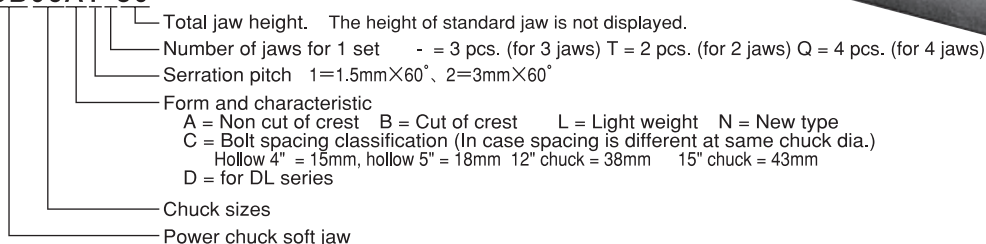

Combination of Soft Jaws ※Chuck models in parentheses are discontinued models.

Standard jaw	High jaw	Adaptive closed centre chuck	Adaptive open centre chuck
SB04C1	SB04C1-036, SB04C1-048		(B-04, HOB-4)
SB04C1T	SB04C1T048		(BT04, HOBT-4)
SB04B1	SB04A1-036, SB04A1-048	N-04 (HJ-4), AS04, NL04, NRC04	
SB04A1T	SB04A1T048	NT04, AT04	
SB04N1	SB04N1-036, SB04N1-048		B-204
SB04N1T			BT204
SB05C1	SB05C1-038, SB05C1-053		(B-05, HOB-5)
SB05C1T	SB05C1T053		(BT05, HOBT-5)
SB05B1	SB05A1-038, SB05A1-053	N-05 (HJ-5)	
SB05A1T	SB05A1T053	NT05	
SB05N1	SB05N1-038, SB05N1-053		B-205
SB05N1T			BT205
SB06B1	SB06A1-066	N-06, NL06, AS06, NRC06, (HJA5-6)	BB206, B-06 (HOB-6, HOS-6, HO-6, HOH-06K, BB06)
SB06A1T	SB06A1T066	NT06, NLTO6, AT06	(BT06, HOBT-6)
SB06C1		(HT-6)	UVE160K
SB06D1		DL206 (DL06)	
SB06L1A			BS306, B-206, HOH-206, BL206
SB06L1T			BT206
SB08B1	SB08A1-056, SB08A1-076	N-08, NL08, AS08, NRC08, DL208 (DL08), (HJA6-8)	BB208, BS308, B-208, HOH-208, BL208, B-08 (HOB-8, HOS-8, HO-8, HOH-08K, BB08)
SB08B1Q	SB08B1Q-76	HW-08	
SB08A1T	SB08A1T056, SB08A1T076	NT08, NLT08, AT08	BT208, (BT08, HOBT-8)
SB10A1	SB10A1-056, SB10A1-080, SB10A1-116	NL10, AS10, NRC10	
SB10B1		N-10, (HJA6-8-10)	BB210, BS310, B-210, BL210, B-10, (HOB-10, HOS-10, HO-10), HOH-10K, UVE200K, UVE250K
SB10A2Q	SB10A2Q080	HW-10, 12	
SB10A2	SB10A2-080	(HJ-10)	
SB10A1T	SB10A1T080	NT10, NLT10, AT10	BT210, (BT10, HOBT-10)
SB10D1		DL210 (DL10)	
SB12A1	SB12A1-090	N-12, NL12, DL212 (DL12), (HJA6-8-12)	B-12, (HOB-12, HOS-12), HOH-12K
SB12C1			UVE315K, (HO-12)
SB12A1T	SB12A1T090	NT12, NLT12	(BT12, HOBT-12)
SB12N1	SB12N1-090		BB212, B-212, BL212
SB12N1T			BT212, BLT212
SB15C1	SB15C1-110		B-15-18, (HOB-15-18, HO-15, HOS-15), HOH-15K
SB15A1	SB15A1-110	(HJA8-15-18-21, HJA11-15)	
SB15A2		(HJ-15)	UVE400K
SB15A2Q		HW-15	
SB15C1T			(BT15, HOBT-15)
SB15N1	SB15N1-110	N-15, N-18	B-215
UVE500AR			(UVE500AR)
SB18A2	SB18A2-110	N-21, N-24, (HJ-18-21, HJA11-18-21)	B-21-24, (HOB-21-24, UVE500K-630K, UVE500AR-630AR, UVE500L, UVE500LB, UVE500LB, UVE630LB)
SB24A2	SB24A2-130	(HJA11-24, HJ-24)	(UVE800K, UVE750AR, UVE800LB)
SB06BB	SB06BB-040		QB306, (QB206)
SB08BB	SB08BB-056		QB308, (QB208)
SB10BB	SB10BB-060		QB310, (QB210)
SB12BB	SB12BB-070		QB312, (QB212)
PW-06		PW-06	
PW-08		PW-08	
PW-10		PW-10	
PW-12		PW-12	
PW-15		PW-15	

Jaws and Accessories

■ Combination Table for Standard Soft Jaws

Chuck	Soft jaw	Chuck	Soft jaw
B-204	SB04N1	N-04	SB04B1
B-205	SB05N1	N-05	SB05B1
B-206	SB06L1A	N-06	SB06B1
B-208	SB08B1	N-08	SB08B1
B-210	SB10B1	N-10	SB10B1
B-212	SB12N1	N-12	SB12A1
B-215	SB15N1	N-15	SB15N1
		N-18	SB15N1
B-04	SB04C1	N-21	SB18A2
B-05	SB05C1	N-24	SB18A2
B-06	SB06B1		
B-08	SB08B1	NL04	SB04B1
B-10	SB10B1	NL06	SB06B1
B-12	SB12A1	NL08	SB08B1
B-15	SB15C1	NL10	SB10A1
B-18	SB15C1	NL12	SB12A1
B-21	SB18A2		
B-24	SB18A2	NT04	SB04A1T
		NT05	SB05A1T
BB206	SB06B1	NLT06	SB06A1T
BB208	SB08B1	NLT08	SB08A1T
BB210	SB10B1	NLT10	SB10A1T
BB212	SB12N1	NLT12	SB12A1T
BB06	SB06B1		
BB08	SB08B1	HW-08	SB08B1Q
		HW-10	SB10A2Q
BS306	SB06L1A	HW-12	SB10A2Q
BS308	SB08B1	HW-15	SB15A2Q
BS310	SB10B1		
		UVE160K	SB06C1
BL206	SB06L1A	UVE200K	SB10B1
BL208	SB08B1	UVE250K	SB10B1
BL210	SB10B1	UVE315K	SB12C1
BL212	SB12N1	UVE400K	SB15A2
		UVE500LB	SB18A2
HOH-206	SB06L1A	UVE500AR	UVE500AR
HOH-208	SB08B1	UVE630LB	SB18A2
HOH-10K	SB10B1	UVE630AR	SB18A2
HOH-12K	SB12A1	UVE750AR	SB24A2
HOH-15K	SB15C1	UVE800LB	SB24A2
QB306	SB06BB	UB450K	UB450
QB308	SB08BB	UB560K	UB560K
QB310	SB10BB	UB630K	UB710
QB312	SB12BB	UB710K	UB710
BT204	SB04N1T	DL206	SB06D1
BT205	SB05N1T	DL208	SB08B1
BT206	SB06L1T	DL210	SB10D1
BT208	SB08A1T	DL212	SB12A1
BT210	SB10A1T	DL06	SB06D1
BT212	SB12N1T	DL08	SB08B1
BT-04	SB04C1T	DL10	SB10D1
BT-05	SB05C1T	DL12	SB12A1
BT-06	SB06A1T		
BT-08	SB08A1T		
BT-10	SB10A1T		
BT-12	SB12A1T		
BT-15	SB15C1T		

■ Combination Table for Standard Soft Jaws

Chuck	Soft jaw	Chuck	Soft jaw
PW-06	SBPW-06	AT04	SB04A1T
PW-08	SBPW-08	AT06	SB06A1T
PW-10	SBPW-10	AT08	SB08A1T
PW-12	SBPW-12	AT10	SB10A1T
PW-15	SBPW-15		
		NRC04	SB04B1
AS04	SB04B1	NRC06	SB06B1
AS06	SB06B1	NRC08	SB08B1
AS08	SB08B1	NRC10	SB10B1
AS10	SB10A1		

■ Interchangeable High jaws with standard jaws

Standard jaw	High jaw
SB04C1	SB04C1-036, SB04C1-048
SB04C1T	SB04C1T048
SB04B1	SB04A1-036, SB04A1-048
SB04A1T	SB04A1T048
SB04N1	SB04N1-036, SB04N1-048
SB05C1	SB05C1-038, SB05C1-053
SB05C1T	SB05C1T053
SB05B1	SB05A1-038, SB05A1-053
SB05A1T	SB05A1T053
SB05N1	SB05N1-038, SB05N1-053
SB06B1	SB06A1-066
SB06A1T	SB06A1T066
SB08B1	SB08A1-056, SB08A1-076
SB08B1Q	SB08B1Q-76
SB08A1T	SB08A1T056, SB08A1T076
SB10B1 (A1)	SB10A1-056, SB10A1-080, SB10A1-116
SB10A2Q	SB10A2Q080
SB10A2	SB10A2-080
SB10A1T	SB10A1T080
SB12A1	SB12A1-090
SB12A1T	SB12A1T090
SB12N1	SB12N1-090
SB15A1	SB15A1-110
SB15C1	SB15C1-110
SB15N1	SB15N1-110
SB18A2	SB18A2-110
SB24A2	SB24A2-130
SB06BB	SB06BB-040
SB08BB	SB08BB-056
SB10BB	SB10BB-060
SB12BB	SB12BB-070

Ref. DWG. 1

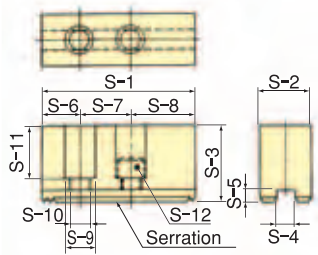

Ref. DWG. 2

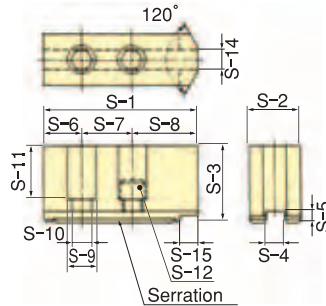

Ref. DWG. 3

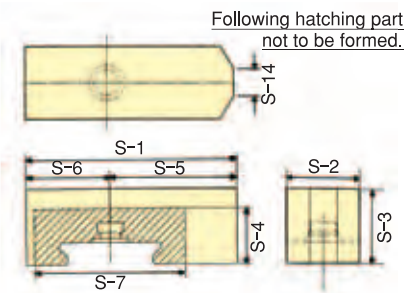

Dimensions

Soft Jaw TYPE	S-1	S-2	S-3	S-4	S-5	S-6	S-7	S-8	S-9	S-10	S-11	S-12	S-14	S-15	Serration pitch	Ref. DWG.
SB04C1	48	19	23	8	3	8	15	25	11	6.6	15	M6	6		1.5×60°	2
SB04C1-036	48	19	36	8	3	8	15	25	11	6.6	28	M6			1.5×60°	1
SB04C1-048	48	19	48	8	3	8	15	25	11	6.6	40	M6			1.5×60°	1
SB04C1T	48	19	23	8	3	8	15	25	11	6.6	15	M6			1.5×60°	1
SB04C1T048	48	19	48	8	3	8	15	25	11	6.6	40	M6			1.5×60°	1
SB04B1	55	23	25	10	4	13	14	28	13.5	8.5	16	M8	3	13	1.5×60°	2
SB04A1-036	55	23	36	10	4	13	14	28	13.5	8.5	27	M8			1.5×60°	1
SB04A1-048	55	23	48	10	4	13	14	28	13.5	8.5	39	M8			1.5×60°	1
SB04A1T	55	23	25	10	4	13	14	28	13.5	8.5	16	M8			1.5×60°	1
SB04A1T048	55	23	48	10	4	13	14	28	13.5	8.5	39	M8			1.5×60°	1
SB04N1	49.5	23	23	10	4	10	14	25.5	13.5	8.5	14.5	M8	4		1.5×60°	2
SB04N1T	49.5	23	23	10	4	10	14	25.5	13.5	8.5	14.5	M8			1.5×60°	1
SB04N1-036	49.5	23	36	10	4	10	14	25.5	13.5	8.5	27.5	M8			1.5×60°	1
SB04N1-048	49.5	23	48	10	4	10	14	25.5	13.5	8.5	39.5	M8			1.5×60°	1
SB05C1	57	23	31	10	3	10	18	29	13.5	8.5	22	M8	12		1.5×60°	2
SB05C1-038	57	23	38	10	3	10	18	29	13.5	8.5	29	M8			1.5×60°	1
SB05C1-053	57	23	53	10	3	10	18	29	13.5	8.5	44	M8			1.5×60°	1
SB05C1T	57	23	31	10	3	10	18	29	13.5	8.5	22	M8			1.5×60°	1
SB05C1T053	57	23	53	10	3	10	18	29	13.5	8.5	44	M8			1.5×60°	1
SB05B1	62	23	27	10	4	14	19	29	13.5	8.5	18	M8	12	14	1.5×60°	2
SB05A1-038	62	23	38	10	4	14	19	29	13.5	8.5	29	M8			1.5×60°	1
SB05A1-053	62	23	53	10	4	14	19	29	13.5	8.5	44	M8			1.5×60°	1
SB05A1T	62	23	27	10	4	14	19	29	13.5	8.5	18	M8			1.5×60°	1
SB05A1T053	62	23	53	10	4	14	19	29	13.5	8.5	44	M8			1.5×60°	1
SB05N1	54	23	25	10	4	12	14	28	13.5	8.5	16.5	M8	5		1.5×60°	2
SB05N1T	54	23	25	10	4	12	14	28	13.5	8.5	16.5	M8			1.5×60°	1
SB05N1-038	54	23	38	10	4	12	14	28	13.5	8.5	29.5	M8			1.5×60°	1
SB05N1-053	54	23	53	10	4	12	14	28	13.5	8.5	44.5	M8			1.5×60°	1
SB06B1	72	31	32	12	5	15	20	37	17	11	20	M10	12	15	1.5×60°	2
SB06A1-066	72	31	66	12	5	15	20	37	17	11	54	M10			1.5×60°	1
SB06A1T	72	31	32	12	5	15	20	37	17	11	20	M10			1.5×60°	1
SB06A1T066	72	31	66	12	5	15	20	37	17	11	54	M10			1.5×60°	1
SB06C1	76.5	40	37	14	5	15	25	36.5	19	13	22	M12			1.5×60°	1
SB06D1	72	31	32	12	5	22	20	30	17	11	20	M10	6	15	1.5×60°	2
SB06L1A	66	26	28	12	5	12	20	34	17	11	16	M10	5	12	1.5×60°	2
SB06L1T	66	26	28	12	5	12	20	34	17	11	16	M10			1.5×60°	1
SB08B1	95	35	38	14	5	24	25	46	19	13	23	M12	12	20	1.5×60°	2
SB08A1-056	95	35	56	14	5	24	25	46	19	13	41	M12			1.5×60°	1
SB08A1-076	95	35	76	14	5	24	25	46	19	13	61	M12			1.5×60°	1
SB08B1Q	90	31	38	12	5	24	20	46	17	11	26	M10	16	24	1.5×60°	2
SB08B1Q-76	90	31	76	12	5	24	20	46	17	11	64	M10	16	24	1.5×60°	2
SB08A1T	95	35	38	14	5	24	25	46	19	13	23	M12			1.5×60°	1
SB08A1T056	95	35	56	14	5	24	25	46	19	13	41	M12			1.5×60°	1
SB08A1T076	95	35	76	14	5	24	25	46	19	13	61	M12			1.5×60°	1
UB450	165	62	66	25.5	8	37	43	85	32	21	43	M20			3.0×60°	1
UB560K	180	65	69.2	25.5	8	39.5	60	80.5	32	21	45.3	M20			3.0×60°	1
UB710	209.5	75	80	30	9	40	60	109.5	39	26	55	M24			3.0×60°	1

Ref. DWG. 4

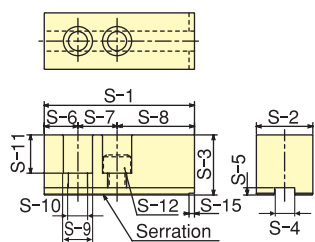

Ref. DWG. 5

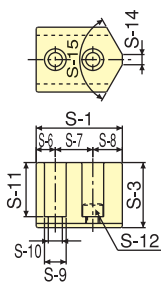
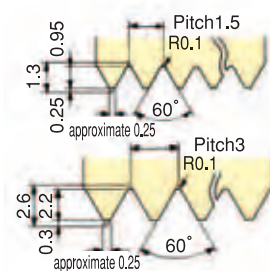
Ref. DWG. 1, 2, 4
Serration

■ Dimensions

Soft Jaw TYPE	S-1	S-2	S-3	S-4	S-5	S-6	S-7	S-8	S-9	S-10	S-11	S-12	S-14	S-15	Serration pitch	Ref. DWG.
SB10B1	110	40	42	16	5	30	30	50	19	13	27	M12	15	20	1.5×60°	2
SB10A1	110	40	42	16	5	30	30	50	19	13	27	M12			1.5×60°	1
SB10A1-056	110	40	56	16	5	30	30	50	19	13	41	M12			1.5×60°	1
SB10A1-080	110	40	80	16	5	30	30	50	19	13	65	M12			1.5×60°	1
SB10A1-116	110	40	116	16	5	30	30	50	19	13	101	M12			1.5×60°	1
SB10A2Q	110	40	42	16	6	30	30	50	19	13	26	M12			3.0×60°	1
SB10A2Q080	110	40	80	16	6	30	30	50	19	13	64	M12			3.0×60°	1
SB10A2	110	40	42	16	6	30	30	50	19	13	26	M12			3.0×60°	1
SB10A2-080	110	40	80	16	6	30	30	50	19	13	65	M12			3.0×60°	1
SB10A1T	110	40	42	16	5	30	30	50	19	13	27	M12			1.5×60°	1
SB10A1T080	110	40	80	16	5	30	30	50	19	13	65	M12			1.5×60°	1
SB10D1	101.5	45	45	18	5	22.5	30	49	22	15	25	M14	15	17.5	1.5×60°	2
SB12A1	129	50	50	18	5	39	30	60	22	15	30	M14			1.5×60°	1
SB12A1-090	129	50	90	18	5	39	30	60	22	15	70	M14			1.5×60°	1
SB12C1	129	50	50	18	5	32	38	59	22	15	35	M14			1.5×60°	1
SB12A1T	129	50	50	18	5	39	30	60	22	15	30	M14			1.5×60°	1
SB12A1T090	129	50	90	18	5	39	30	60	22	15	70	M14			1.5×60°	1
SB12N1	111	50	50	21	4	21	30	60	25	17	33	M16			1.5×60°	1
SB12N1-090	111	50	90	21	4	21	30	60	25	17	73	M16			1.5×60°	1
SB12N1T	111	50	50	21	4	21	30	60	25	17	33	M16		6	1.5×60°	1
SB15C1	165	62	66	22	8	37	43	85	32	21	42	M20		6	1.5×60°	4
SB15C1-110	165	62	110	22	8	37	43	85	32	21	86	M20			1.5×60°	4
SB15A1	156	62	70	22	8	36	60	60	32	21	45	M20			1.5×60°	1
SB15A1-110	156	62	110	22	8	36	60	60	32	21	85	M20			1.5×60°	1
SB15A2	156	62	70	22	9	36	60	60	32	21	45	M20			3.0×60°	1
SB15A2Q	129	50	50	18	6	32	38	59	22	15	34	M14		6	3.0×60°	1
SB15C1T	165	62	66	22	8	37	43	85	32	21	42	M20			1.5×60°	4
SB15N1	135	50	60	25.5	5	26	43	66	32	21	39	M20			1.5×60°	1
SB15N1-110	135	50	110	25.5	5	26	43	66	32	21	89	M20			1.5×60°	1
UVE500AR	210	65	100	25	9	40	60	110	32	21	75	M20			3.0×60°	1
SB18A2	180	65	70	25	9	40	60	80	32	21	45	M20			3.0×60°	1
SB18A2-110	180	65	110	25	9	40	60	80	32	21	85	M20			3.0×60°	1
SB24A2	210	75	90	25	9	40	80	90	32	21	65	M20			3.0×60°	1
SB24A2-130	210	75	130	25	9	40	80	90	32	21	105	M20			3.0×60°	1
SB06BB	90	32	30	24	54	36	68							5		3
SB06BB-040	90	32	40	24	54	36	68							5		3
SB08BB	106	37	38	28	64	42	76							14		3
SB08BB-056	106	37	56	28	64	42	76							14		3
SB10BB	125	42	42	31	76	49	88							26		3
SB10BB-060	125	42	60	31	76	49	88							26		3
SB12BB	139	42	50	34	90	49	92							30		3
SB12BB-070	139	42	70	34	90	49	92							30		3
PW-06	67.5	50.8	51	38.07	3.3	15	29.36	23.14	17	11	42.4	M10	8	120°		5
PW-08	74	57	57.47	44.45	3.3	15	34.14	24.86	20	13.5	47	M12	41	90°		5
PW-10	89.5	70.1	70.2	57.1	3.3	19	44.45	26.05	25	17	59	M16				5
PW-12	108.5	70.1	70.2	57.1	3.3	19	44.45	45.05	25	17	59	M16				5
PW-15	140	76.2	76.5	66.62	3.3	23.9	53.98	62.12	32	21	61.2	M20				5



CHUCK

Hard Jaws for Power Chuck HB series

Description of Model HB06B1

- Serration pitch
1=1.5mm×60°, 2=3mm×60°, 3=1/16"×90°, 4=3/32"×90°
- Form and characteristic
A = 3-step jaw B = 2-step jaw
C = Bolt spacing classification (In case spacing is different at same chuck dia.)
U = for UVE N = New type
- Chuck sizes
- Power chuck hard jaw

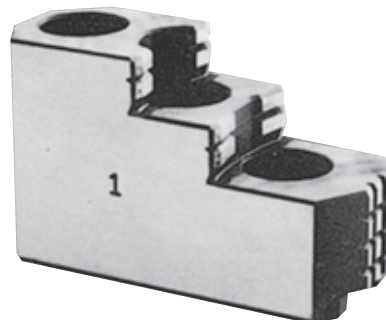

Combination of Hard Jaws *Chuck models in parentheses are discontinued models.

Hard Jaw TYPE	Adaptive closed centre chuck	Adaptive open centre chuck
HBO4B1		(B-04)
HBO4N1	N-04	B-204, B-205
HBO5C1	N-05	
HBO6A1	N-06, NLO6, (HJA5-6)	BB206, BS306, B-206, HOH-206, BL206, (BB06)
HBO6B1	N-06, NLO6, (HJA5-6)	BB206, BS306, B-206, HOH-206, BL206, (BB06) B-06, (HOB-6, HOS-6, HO-6)
HBO8A1	N-08, NLO8, (HJA6-8)	B-208, HOH-208, BL208, B-08, (HOB-8, HOS-8, HO-8)
HBO8B1		BB208, BS308
HBO8N1		(BB08)
HB10A1	N-10, NL10, (HJA6-8-10)	B-210, HOH-10K, BL210, B-10, (HOB-10, HOS-10, HO-10)
HB10AA1		BB210, BS310
HB12B1	N-12, NL12, (HJA6-8-12, HLA6-12, HLA6-8-15)	HOH-12K, B-12, (HOB-12, HOS-12, HO-12)
HB12C1		(HO-12)
HB12N1		BB212, B-212, BL212
HB15A1		HOH-15K, B-15, (HOB-15, HOS-15, HO-15), B-18, (HOB-18)
HB15B1	(HJA8-15-18-21, HJA11-15, HLA-18-21)	
HB15N1	N-15, N-18, NV15, NV18	B-215
HB18B2	N-21, N-24, NV21, NV24, NV28, NV32, NV36, NV40, (HJA11-18-21, HJA15-21)	B-21 (HOB-21), B-24 (HOB-24) (UVE500, UVE630)
HB24B2	(HJA11-15-24)	(UVE800)
HBO6U1		UVE160K
HBO8U1		UVE200K, UVE250K
HB12U1		UVE315K
HB16U2		UVE400K
HB18W2		UB450K

Ref. DWG. 1

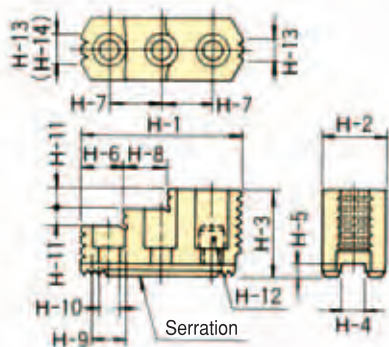

Ref. DWG. 2

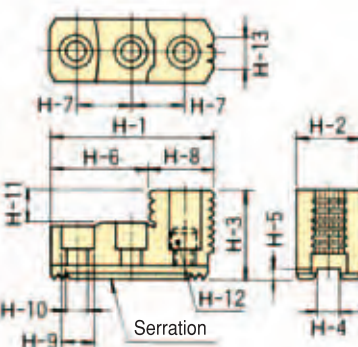

Ref. DWG. 3

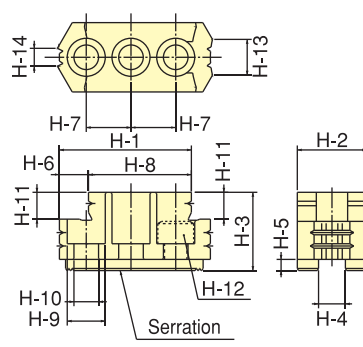

Dimensions

Hard Jaw TYPE	H-1	H-2	H-3	H-4	H-5	H-6	H-7	H-8	H-9	H-10	H-11	H-12	H-13	H-14	Serration pitch	Ref. DWG.
HBO4B1	46	19	23	8	3	15	15	23.5	11	6.6	9	M 6	6	—	1.5	3
HBO4N1	53	23	27.5	10	4	30.5	14	22.5	13.5	8.5	10	M 8	6	—	1.5	2
HBO5C1	61	23	30	10	4	7.5	19	53.5	13.5	8.5	12	M 8	6	—	1.5	2
HBO6A1	66.6	31	36	12	5	40	20	26.6	17	11	12	M10	10	—	1.5	2
HBO6B1	67.5	31	35	12	5	13	20	46	17	11	12	M10	16	10	1.5	3
HBO8A1	86	35	51	14	5	31	25	18	19	13	12	M12	12	12	1.5	1
HBO8B1	92	35	51	14	5	12	25	63	19	13	18	M12	11	11	1.5	3
HBO8N1	88	35	51	14	5	36	25	14	19	13	12	M12	12	11	1.5	1
HB10A1	99.5	40	54	16	5	43	30	17	19	13	13	M12	15	15	1.5	1
HB10AA1	102.5	40	54	16	5	43	30	17	19	13	13	M12	15	15	1.5	1
HB12B1	97.5	50	55	18	5	64.5	30	33	22	15	20	M14	30	—	1.5	2
HB12C1	113	50	50	18	5	69.5	38	43.5	22	15	20	M14	18	—	1.5	2
HB12N1	103	50	52	21	4	62.5	30	40.5	25	17	17	M16	30	—	1.5	2
HB15A1	149	62	86	22	8	63	43	34	32	21	20	M20	40	40	1.5	1
HB15B1	141.75	70	77.5	22	8	87.75	43	54	32	21	30	M20	50	—	1.5	2
HB15N1	149	62	86	25.5	5	69	43	27	32	21	20	M20	43	38	1.5	1
HB18B2	159.5	80	90	25	9	104.5	50	55	32	21	40	M20	55	—	3.0	2
HB24B2	183.5	90	105	25	9	116.5	60	67	32	21	50	M20	76	—	3.0	2
HBO6U1	69.5	35	48	14	5	34	19	18	19	13	12	M12	12	20	1.5	1
HBO8U1	79.25	40	42	16	5	35.25	21	44	19	13	14	M12	12	—	1.5	2
HB12U1	107.25	45	50	18	5	56.75	30	50.5	22	15	20	M14	25	—	1.5	2
HB16U2	138.5	60	71	22	9	76.5	43	62	32	21	26	M20	35	—	3.0	2
HB18W2	155.5	60	85	25.5	9	79.5	43	24	32	21	20	M20	38	—	3.0	1



T-nut

Ref. DWG. 1

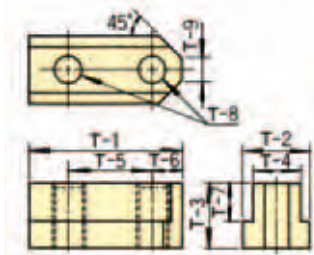

※T-8 is the size of soft jaw mounting bolt.

Ref. DWG. 2

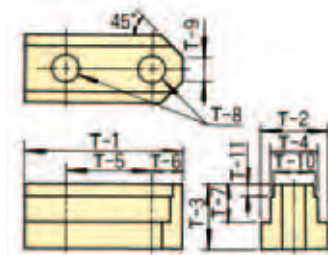

※T-8 is the size of soft jaw mounting bolt.

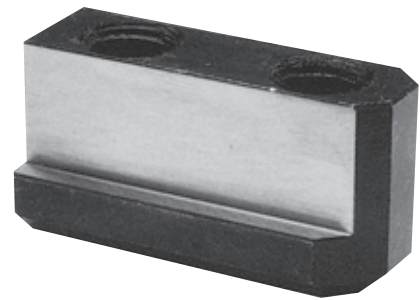

Ref. DWG. 3

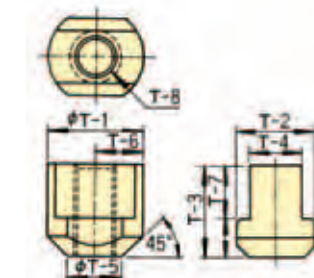

※T-8 is the size of soft jaw mounting bolt.

Ref. DWG. 4

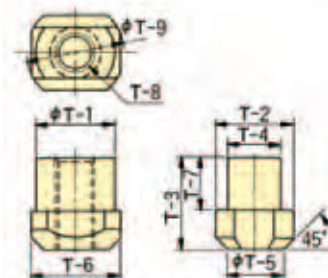

※T-8 is the size of soft jaw mounting bolt.

Ref. DWG. 5

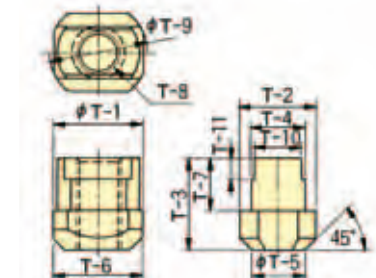

※T-8 is the size of soft jaw mounting bolt.

※Please inform us of the chuck type and T-Nut dimensions before ordering.

■Dimensions and Combination

※Chuck models in brackets are discontinued models.

T-1	T-2	T-3	T-4	T-5	T-6	T-7	T-8	T-9	T-10	T-11	Adaptive chuck	Ref. DWG.
24.5	11.5	13.5	8	15	4.5	9	M6	5	—	—	(B-04, BT04)	1
26	14.5	15	10	14	6	9.5	M8	5	—	—	B-204, BT204, B-205, BT205	1
26	14.5	18	10	14	6	12.5	M8	5	—	—	N-04, NT04, NL04, AS04, AT04, NRC04, (HJ-4)	1
30	14	15.5	10	18	6	10	M8	5	—	—	(B-05, BT05, HOB-5, HOBT-5)	1
32	14.5	18	10	19	6	12.5	M8	6	—	—	N-05, NT05, (HJ-5)	1
36.5	17	18.5	12	20	8.25	11	M10	8	—	—	HW-08	1
36.5	17	22.5	12	20	7.5	15	M10	8	—	—	N-06, (NT06, HJ-6), NL06, NLT06, AS06, AT06, NRC06	1
46.5	20	20.5	14	25	10.5	12	M12	12	—	—	B-208, BB208, BS308, BT208, HOH-208, BL208, BLT208	1
48	20	25.5	14	25	11	16	M12	8	—	—	N-08, (NT08, HJ-8), NL08, NLT08, AS08, AT08, NRC08	1
51	22	21.5	16	30	11	13	M12	11	—	—	B-210, BB210, BS310, BT210, BL210, BLT210	1
55	22	25.5	16	30	11	16	M12	8	—	—	N-10, (NT10, HJ-10), NL10, NLT10, AS10, AT10, NRC10, HW-10, HW-12	1
56.25	29.5	22.75	21	30	12	11.25	M16	9.5	—	—	BB212	1
55.5	29.5	27.75	21	30	12	16.25	M16	13	—	—	B-212, BT212, BL212, BLT212	1
55.5	26.5	31	18	30	11.5	17.5	M14	12	—	—	HOH-12K	1
55.5	26.5	33.5	18	30	11.5	20	M14	12	—	—	N-12, (NT12), NL12, NLT12	1
62.5	26.5	33.5	18	38	12	20	M14	12	—	—	HW-15, (HJ-12)	1
90	37.5	45	25	50	20	26	M20	16	—	—	B-21-24, (HOB-21-24) For hard jaw	1
100	37.5	45	25	60	20	26	M20	16	—	—	B-21-24, (HOB-21-24) For soft jaw	1
100	37.5	54	25	60	20	35	M20	16	—	—	(HJ-18, HJ-21)	1
100	40	54	25	60	20	35	M20	16	—	—	(HJA11-24 For hard jaw)	1
120	40	54	25	80	20	35	M20	16	—	—	(HJ-24, HJA11-15-24)	1
80	33.5	40.5	24	43	17	24	M20	11	22	7.5	HOH-15K	2
80	33.5	45.5	24	43	17	29	M20	11	22	8.2	(HLA8-18, HJA11-15)	2
97	33.5	45.5	24	60	17	29	M20	11	22	8.5	(HJ-15, HJA8-11-15, HLA8-18-21)	2
80	35	39.25	25.5	43	17	20.25	M20	14	—	—	B-215	1
42	35	39.25	25.5	25	—	20.25	M20	—	—	—	N-15, N-18	3
46	37.5	45	25	26.5	—	26	M20	—	—	—	N-21, N-24	3
19	22.5	23.5	14	19.5	19	15	M12	24.5	—	—	UVE160	4
19	22.5	24	16	19.5	19	15.5	M12	24.5	—	—	UVE200, UVE250	4
24	28.5	27.5	18	24	24	17	M14	32	—	—	UVE315	4
32	36	30.5	24	30	32	20	M20	40	22	8.5	UVE400	5
100	36	31.5	25	60	20	21	M20	16	—	—	(UVE500LB, UVE630LB)	1
120	36	31.5	25	80	20	21	M20	16	—	—	(UVE800LB)	1
32	36	31.5	25	30	32	21	M20	40	—	—	(UVE500AR)	4
32	37.5	45.5	25	30	34	26	M20	42	—	—	(UVE550AR, UVE630AR, UVE750AR)	4
46	19.8	10.7	12.65	29.36	8.5	6	M10	—	—	—	PW-06	1
53.2	21.6	12.9	14.24	34.14	9.5	7.4	M12	—	—	—	PW-08	1
68.45	27.4	17	19	44.45	12	10	M16	—	—	—	PW-10, PW-12	1
32	36	29.5	25.5	32	32	19	M20	42	—	—	UB450K, UB560K	4
—	44	44	30	32	36	26	M24	52	—	—	UB630K, UB710K	4



CHUCK

Hard Jaws for Scroll Chuck HBS series

Description of Model **HBS06C**

- Chuck type
C=JN
- Chuck sizes
- Hard jaw of scroll chuck



■ Combination Table for Hard Jaws

Hard jaw type	Adaptive chuck model
HBS06C	JN06T, JN06RA5
HBS07C	JN07T, JN07RA5, JN08RA6
HBS09C	JN09T, JN09RA6
HBS10C	JN10T, JN10RA6 (8)
HBS12C	JN12T, JN12RA6 (8)

■ Dimensional Drawings

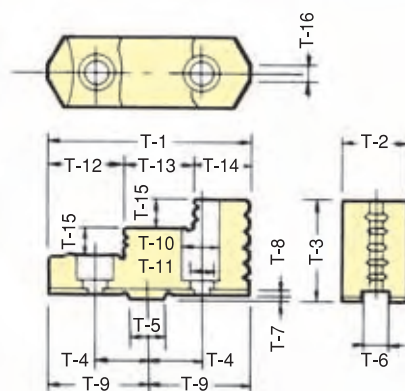
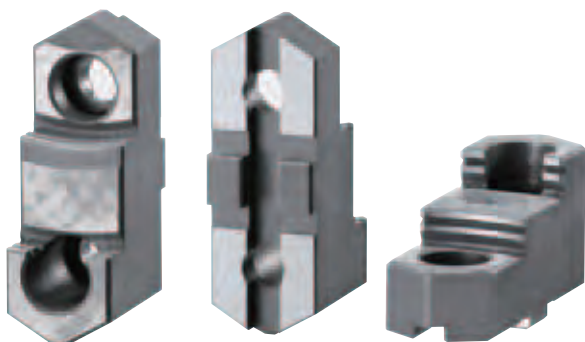

■ Dimensions

TYPE	Chuck size	T-1	T-2	T-3	T-4	T-5	T-6	T-7	T-8	T-9	T-10	T-11	T-12	T-13	T-14	T-15	T-16	Mounting bolt
HBS06C	6	68	26	37	19.05 ^{+0.1}	12.68 ^{+0.008/-0.003}	7.94 ^{+0.05/0}	3	3.5	34	14	8.5	26	21.5	20.5	8.5	2	M 8 × 20
HBS07C	7	80	28	40	22.225 ^{+0.1}	12.68 ^{+0.008/-0.003}	7.94 ^{+0.05/0}	3	3.5	40	17	11	30.5	26	23.5	9.5	2	M10×20
HBS09C	9	90	32	48	26.99 ^{+0.1}	19.03 ^{+0.009/-0.004}	12.7 ^{+0.05/0}	3	3.5	45	19	13	34	30	26	12	3	M12×25
HBS10C	10	100	35	52	26.99 ^{+0.1}	19.03 ^{+0.009/-0.004}	12.7 ^{+0.05/0}	3	3.5	50	19	13	38	32	30	14	3	M12×25
HBS12C	12	115	40	54	31.75 ^{+0.1}	19.03 ^{+0.009/-0.004}	12.7 ^{+0.05/0}	3	3.5	57.5	19	13	46	35	34	15	4	M12×25



CHUCK

Soft Jaws for Scroll Chuck

SBS series

Description of Model **SBS06**

Chuck sizes
Soft jaw of scroll chuck



Combination Table for Soft Jaws

Soft jaw type	Adaptive chuck model	Old chuck model
SBS03	SC-3F	
SBS04	SC-4F	
SBS05	SC-5F	
SBS06	JN06T, JN06RA5	SK-6, KA5-165, KA5C-6
SBS07	JN07T, JN07RA5, JN08RA6, JT07	SK-7, KA5-190, KA6C-200, KA6C-8
SBS09	JN09T, JN09RA6, JT09	SK-9, KA6-230
SBS10	JN10T, JN10RA6 (8)	SK-10, KA6 (8)-270, KA6 (8) C-10
SBS12	JN12T, JN12RA6 (8)	SK-12, KA6 (8)-310, KA6 (8) C-12



Dimensional Drawings

SBS03, SBS04, SBS05

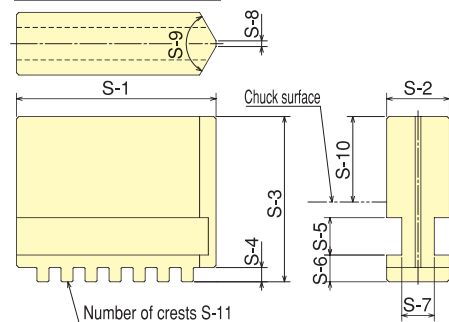

SBS06, SBS07, SBS09, SBS10, SBS12

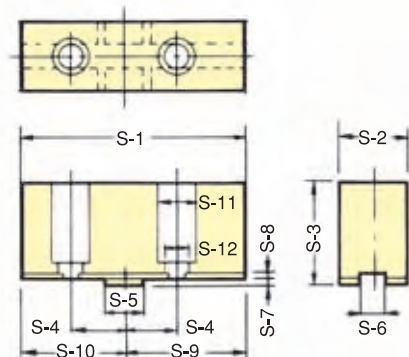

Dimensions

TYPE	Chuck size	S-1	S-2	S-3	S-4	S-5	S-6	S-7	S-8	S-9	S-10	S-11	S-12	Mounting bolt
SBS03	3	35	11	29	2.5	6.55	4.7	5.7	1	120°	15	7		
SBS04	4	42	14	34.5	3.5	6.55	6.2	7.2	1.5	120°	18	7		
SBS05	5	50	16	40	4	8.2	7.7	7.2	1.5	120°	20	7		
SBS06	6	75	26	38	19.05 ^{+0.1}	12.68 ^{+0.008/-0.003}	7.94 ^{+0.05/0}	3	3.5	41	34	14	8.5	M 8 x 20
SBS07	7	88	28	41	22.225 ^{+0.1}	12.68 ^{+0.008/-0.003}	7.94 ^{+0.05/0}	3	3.5	48	40	17	11	M10 x 20
SBS09	9	100	32	48	26.99 ^{+0.1}	19.03 ^{+0.009/-0.004}	12.7 ^{+0.05/0}	3	3.5	55	45	19	13	M12 x 25
SBS10	10	110	35	52	26.99 ^{+0.1}	19.03 ^{+0.009/-0.004}	12.7 ^{+0.05/0}	3	3.5	60	50	19	13	M12 x 25
SBS12	12	125	40	54	31.75 ^{+0.1}	19.03 ^{+0.009/-0.004}	12.7 ^{+0.05/0}	3	3.5	67.5	57.5	19	13	M12 x 25



CHUCK

Back Plate

■ Back Plate Acceptable table

Model	Nose	5	6	8	11	15
B-200	6	CB-06A05				
	8		CB-08A06			
	10		CB-10A06	CB-10A08		
	12		CB-10A06	CB-10A08		
	15			CB-15A08	CB-15A11	
B	15			CB-15A08	CB-15A11	
	18				CB-18A11	
	21					CB-21A15
	24					CB-21A15
BB200	6	CB-06A05				
	8		CB-08A06			
	10		CB-10A06	CB-10A08		
	12		BB212A600	CB-15A08		
BS300	6	BS306A500				
	8		BS308A600			
	10		BS310A600	BS310A800		
BL200	6	CB-06A05				
	8		CB-08A06			
	10		CB-10A06	CB-10A08		
	12		CB-10A06	CB-10A08		
QB300	6	CB-06A05				
	8		CB-08A06			
	10		CB-10A06	CB-10A08		
	12		CB-10A06	CB-10A08		
BT200	6	CBT06A05				
	8		CBT08A06			
	10		CBT10A06	CBT10A08		
	12		CBT10A06	CBT10A08		
BLT200	6	CBT06A05				
	8		CBT08A06			
	10		CBT10A06	CBT10A08		
	12		CBT10A06	CBT10A08		
N	6	CB-06A05				
	8		CB-08A06			
	10		CN-10A06	CB-10A08		
	12		CN-10A06	CB-10A08		
	15			CN-15A08	CB-15A11	
	18			CN-15A08	CB-15A11	
	21			CN-21A08	CN-21A11	CB-21A15
	24				CN-21A11	CB-21A15
NL	6	CB-06A05				
	8		CB-08A06			
	10		CN-10A06	CB-10A08		
	12		CN-10A06	CB-10A08		
	18			CN-15A08	CB-15A11	
ML	6	CB-06A05				
	8		CB-08A06			
NT	15			CBT15A08	CBT15A11	
NLT	6	CBT06A05				
	8		CBT08A06			
	10		CNT10A06	CBT10A08		
	12		CBT10A06	CBT10A08		
MLT	6	CBT06A05				
	8		CBT08A06			
MLV	6	CBT06A05				
	8		CBT08A06			



CHUCK

Chuck Bung

■ Dimensional Drawings

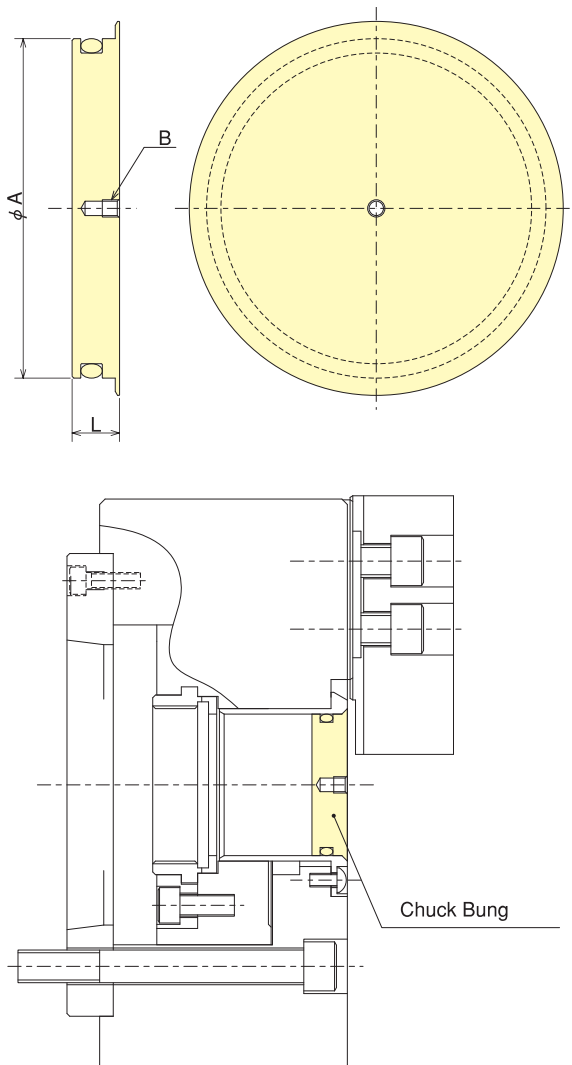

■ Dimensions

Chuck Model	Dimension			O-ring
	A	L	B	
B-15	117.5	16.5	—	P105
B-18	117.5	15	M6	P105
B-21	140	15	M6	P130
B-24	165	15	M6	G155
B-28	195	15	M6	G185
B-204	26	9	M5	P22
B-205	33	12	M5	P26
B-206	45	13	M6	P38
B-208	52	13	M6	P46
B-210	75	15	M6	P65
B-212	91	15	M6	P80
B-215	100	17	M6	P90
BB206	53	13	M6	P46
BB208	66	15	M6	P56
BB210	81	15	M6	P71
BB212	106	15	M6	P95
BL206	28	12	M5	P22A
BL208	45	13	M6	P38
BL210	53	13	M6	P46
BL212	63	15	M6	P53
BS306	45	13	M6	P38
BS308	52	13	M6	P46
BS310	75	15	M6	P65



CHUCK

Chuck Grease CHUCK GREASE PRO

Chuck Gripping Force 1.5 times
(Compared to Standard Grease)

Service Life 3 times
(Compared to Standard Grease)



- Conforms to international standards for health, safety and the environment
- Loss of grip over time is reduced
Refer to graph below for B206 chuck.
- White grease is cleaner and reduces contamination
- Various sizes available; 18kg can, 1kg can, 400g bellows and 400g DIN cartridge

Chuck Grease Pro has been specially developed by Kitagawa by utilising long term experience in many applications.

The use of Chuck Grease Pro will extend life, increase gripping force and improve safety.

Fig.1 Gripping force check by grease

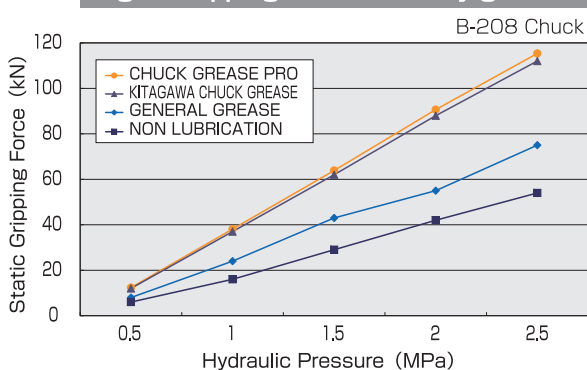
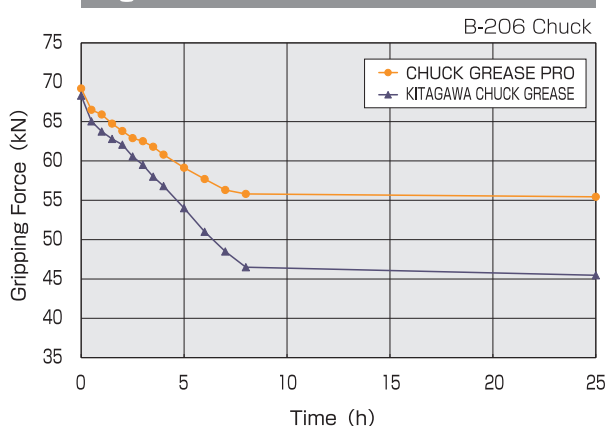

Fig.2 Grease Check Test



*The graphs show the grease performance, not the condition of using Chuck. Please refer to Chuck specification table for the condition of Chuck.

Using method

Grease the chuck with a commercial grease gun according to the instruction manual of the chuck as well as general grease.

Features

Color	Lemon yellow ~ yellow paste form
Density g/cm ³	1.12
Temperature range °F (°C)	18~300 (-28~149)
Friction factor	0.06~0.1 (by LFW-1 Rotary Reciprocating Test Machine)
NLGI Consistency	#2
JIS K-2220 PS consistency	Mixing 60 times 265-295



CHUCK

Chuck Grease GREASE NIPPLE

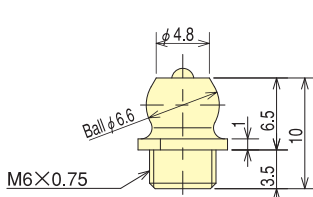

61S403879

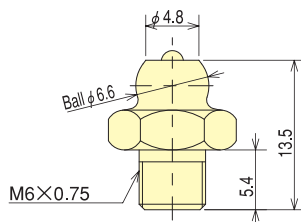

A M6

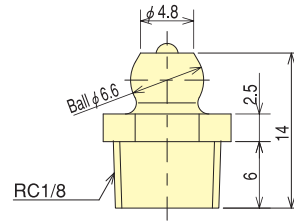

WA-100

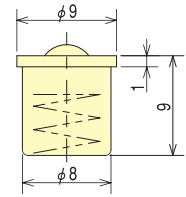

Ball cup 8.0

Grease nipple details

Model	Counterbore dia.	Grease nipple type (DWG No.)	Model	Counterbore dia.	Grease nipple type (DWG No.)
B-204	φ12	61S403879	UVE200K	φ12	A M6
B-205	φ12	61S403879	UVE250K	φ12	A M6
B-206	φ15	A M6	UVE315K	φ12	A M6
B-208	φ15	A M6	UVE400K	φ12	A M6
B-210	φ15	A M6	UB series	φ15	WA-100
B-212	φ15	A M6	UBR series	φ15	WA-100
B-215	φ15	A M6	KPC series	M5	M5 Setscrew
B series	φ15	A M6	DL06	φ15	61S403879
BB200 series	φ15	61S403879	DL08	φ15	A M6
BS306	φ15	61S403879	DL10	φ15	A M6
BS308	φ15	A M6	DL12	φ15	A M6
BS310	φ15	A M6	PW series	φ15	A M6
BL200 series	φ15	A M6	PWT series	φ15	A M6
HOH-206	φ15 (Body) φ15 (Lever)	61S403879	PUB series	φ15	A M6
HOH-208	φ15 (Body) φ17 (Lever)	61S403879, A M6	PU203	φ12	A M6
HOH-10K	φ15 (Body) φ17 (Lever)	A M6	PU204	φ15	A M6
HOH-12K	φ15 (Body) φ19 (Lever)	A M6	PU205	φ15	A M6
HOH-15K	φ15 (Body) φ21 (Lever)	A M6	PU206	φ15	A M6
QB306	φ15	61S403879	PU208	φ15	A M6
QB308	φ15	A M6	PU210	φ15	A M6
QB310	φ15	A M6	PU212	φ15	A M6
QB312	φ15	A M6	PUE series	φ15	A M6
BT204	φ12	61S403879	LU series	φ15	A M6
BT205	φ12	61S403879	FGT05/FG05	φ12	A M6
BT206	φ15	A M6	FGT06/FG06	φ15 (Body) φ12 (Finger bushing)	A M6
BT208	φ15	A M6	FGT08/FG08	φ15	A M6
BT210	φ15	A M6	FGT10/FG10	φ15	A M6
BT212	φ15	A M6	FGT12/FG12	φ15	A M6
BLT206	φ15	A M6	FG-V series	φ15 (Plunger)	A M6
BLT208	φ15	A M6	FG-L series	φ15 (Plunger)	61S403879
BLT210	φ15	A M6	FG48MR	Filling type in assembling	Filling in spherical surface part
BLT212	φ15	A M6	FG52M	φ15 (Plunger)	61S403879
N-04	φ15	A M6	FG-Q series	φ14 (Plunger)	A M6
N-05	φ15	A M6	SC-3(F)	Ball cup	Ball cup 8.0
N-06	φ15	A M6	SC-4(F)	Ball cup	Ball cup 8.0
N-08	φ15	A M6	SC-5(F)	Ball cup	Ball cup 8.0
N-10	φ15	A M6	JN06	φ15	61S403879
N-12	φ15	A M6	JN07	φ15	61S403879
N-15	φ15	A M6	JN09	φ15	61S403879
N-18	φ15	A M6	JN10	φ15	61S403879
N-21	φ15	WA-100	JN12	φ15	61S403879
N-24	φ15	WA-100	SC-14	Ball cup	Ball cup 8.0
NL04	φ15	A M6	SC-16	Ball cup	Ball cup 8.0
NL06	φ15	A M6	JN-T series	φ15	61S403879
NL08	φ15	A M6	JN-RA series	φ15	61S403879
NL10	φ15	A M6	JT series	φ15	61S403879
NL12	φ15	A M6	JS series	φ15	61S403879
NL18	φ15	A M6	AS04	φ15	61S403879
ML series	φ15	A M6	AS06	φ15	A M6
NT series	φ15	A M6	AS08	φ15	A M6
NLT series	φ15	A M6	AS10	φ15	A M6
MLT series	φ15	A M6	AT04	φ15	61S403879
MLV series	φ15	A M6	AT06	φ15	A M6
HW-08	φ24	A M6	AT08	φ15	A M6
HW-10	φ14	A M6	AT10	φ15	A M6
HW-12	φ14	A M6	PLS series	φ15	A M6
HW-15	φ17	A M6	JM200	φ15	A M6
UVE160K	φ12	A M6	SC-S series	Ball cup	Ball cup 8.0



CHUCK

Stationary Gripping Meter JFT-S100

Gripping force can be checked at a glance!

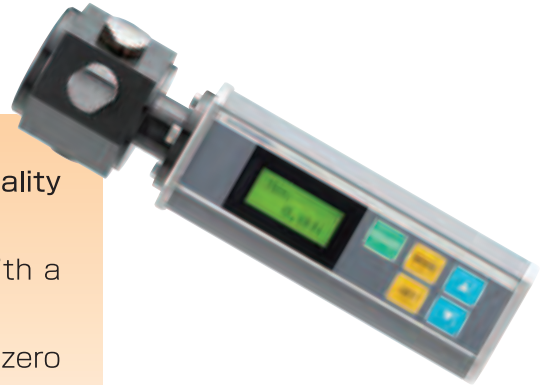

Compact design with excellent workability
Chuck gripping force is quantified, thus improving quality control and safety!

- **Compact and integral**
Integrated detector and display. Easy to handle with a low weight of only 1.3kg!
- **Zero adjustment NOT required**
Enables quick measurement with the automatic zero adjustment function!
- **Measured value memory function**
Stores three required measured values, and enables later checking.
- **Power-saving function**
Saves power with the automatic power-off function.
- **Battery voltage drop, excessive input, out-of-range zero adjustment, etc.**

The calibration certificate for ISO-9001 can be issued (option)

Dimensional Drawings

When the number of gripping points is 3.

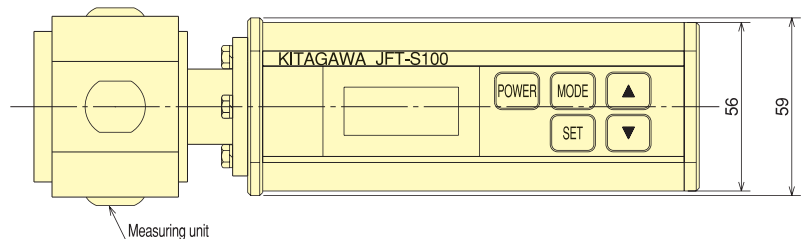
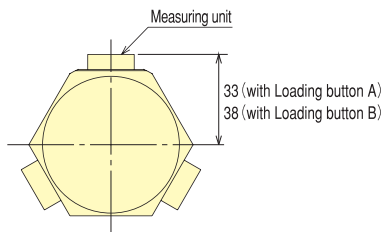

When the number of gripping points is 2.

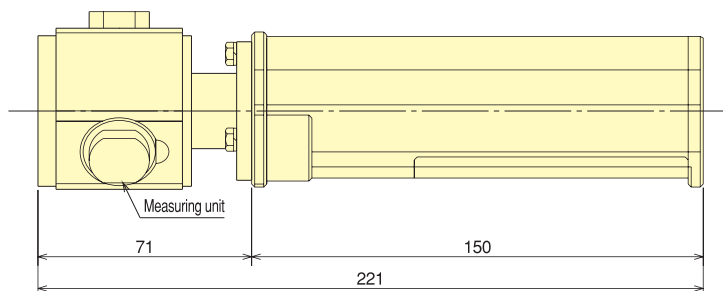
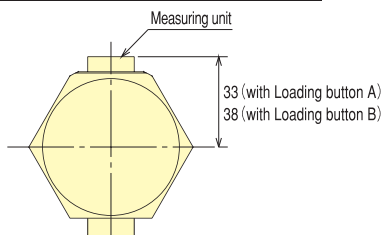

Specifications

Loading Cell	
Constant Capacity(per jaw)	100 kN
Allowable load	150 %
Gripped points	Two or three positions
Accuracy	±2 % R.O.
Measurable diameter	φ62~φ65mm (with Loading button A) φ62~φ75mm (with Loading button B)

Display	
Measuring range	0.5~100 kN
Max. Display	110.0 kN
Display unit	0.1 kN
Operation Switch	Sheet Switch Panel
Display unit	LCD Character display (8×2 line with Back light)

Others	
Power	Lithium Battery (CR123A) ×2sets
Operation Temperature	0~50°C
Operation Humidity	80%RH or less
Weight	1.3 kg
Accessory	Loading button A (H 7mm) ×3pieces Loading button B (H 12mm) ×3pieces Battery for operation check (CR123A ×2pieces)



CHUCK

Compatibilities of Lathes to Short Taper Chucks

	Model	First Spindle	Second Spindle	
		Nose (JIS)	Nose (JIS)	
AMADA MACHINE TOOLS	L	3-J2,3-J3	A1-6	—
		5-J2,5-J3	A2-8	—
		6-J	A1-11	—
		7-J	A2-11	—
		12-C,15-C	A1-8	—
	LE(G)	19K	A1-6	—
	LEO(G)	80A,125A	A1-6	—
	LG	5,6,7,7M	A2-4	—
		7F,8,8M,8MC	A2-6	—
		3A	A2-4	—
	LJ	3B,5B	A2-6	—
		6,10,6M(MC),10M(MC)	A2-8	—
		32N,50N	A1-6	—
	LN	35C	A1-5	—
	LPT	55A	A1-5	—
	LR	5(M,D,DM)	A2-4	—
	SH	10,10S	A2-6	—
	SL	12	A2-8	—
	TH	5(M)	A2-4	—
		10(M)	A2-6 (at special: A2-4)	—
	G	04T,04-UP	Special	—
		05-UP	φ95 Flat	—
		05,06,07,07-M	φ100 Flat	—
		G-5	φ80 Flat	—
		07-F	A2-6	—
	J	1	φ100 Flat	—
		f-1,J-1	φ80 Flat	—
		3	A2-6	—
		5	A2-6/A2-8	—
	A	i8,i8f	φ56 Flat/φ80 Flat	—
		12,D-12	A2-6	—
		18-S,D-18S	A2-8	—
	IKEGAI	AN	20N	A2-6
25N			A2-8	—
AX		30N	A2-8	—
		40B	A2-15	—
EC18			A1-5	—
ED18			A1-5	—
FT		20	A2-6	—
		20U,25U,20J,25J,600	A2-8	—
FX		10N	A1-5	—
		15N,MINI	Straight, plate	—
		20N	A1-6	—
		20II	A2-6	—
		25W,25II	A2-8	—
		LX20N	A1-6	—
TC		8,10	Straight, plate	—
	15	A2-6	—	
	25	A2-8	—	
TCR	15	A2-6	—	
	25,25Y	A2-8	—	
TU	15	A2-6	—	
TUR	15	A2-6	—	
TM25YS	Sub	A2-6	—	
	Maine	A2-8	—	
OKUMA	LB	2000EX	φ140 Flat (A2-6)	φ140 Flat
		2500EX	A2-6	—
		3000EX	A2-6(A2-8,A2-11)	φ140 Flat
		4000EX	A2-8(A2-11)	—
		35II	A2-8(A2-11,A2-15)	—
		45II	A2-11(A2-20)	—
	LU	300	φ140 Flat(A2-6,A2-8)	—
		400	A2-8(A2-11)	—
		35	A2-8(A2-11,A2-15)	—
		45	A2-11(A2-20)	—
	LCS	250	A2-6(A2-8)	—
		25	A2-8	—
	2SP	150H	φ140 Flat	—
		250H	A2-6	—
		10HG	φ140 Straight	φ140 Straight
		25HG	A2-6	A2-6
		35HG,V40	A2-8	A2-8
	V60,V80		A2-11	A2-11
		LFS	φ140 Straight	φ140 Straight
	10M-2SP		φ140 Straight	φ140 Straight
		3SP	25HG	A2-6
	LVT	300	A2-6	—
		400	A2-8	—
	LAW	F II,2S	A2-8	—
		V24	A2-11	—
	MAC TURN	250	A2-6(A2-8)	φ140 Flat(A2-6)
		350	A2-6(A2-8)	φ140 Flat(A2-6,A2-8)
550		A2-8(A2-11)	A2-8	

	Model	First Spindle	Second Spindle	
		Nose (JIS)	Nose (JIS)	
OKUMA	MULTUS	B200	φ140 Flat	—
		B200(W)	φ140 Flat	φ140 Flat
		B300	A2-6(A2-8)	—
		B300(W)	A2-6(A2-8)	A2-6
		B400	A2-8(A2-11)	—
	B400(W)		A2-8(A2-11)	A2-8
		LT	200-M	φ140 Flat(A2-6)
		300-M	A2-6(A2-8)	A2-6(A2-8)
	LOC	650	A2-15(A2-20,φ725 Flat)	—
	LH(※)	55-N	A2-11(A2-15,A2-20)	—
	HJ	18	φ140 Straight	—
		28,250	A2-6	—
	HL	20	A2-6	—
		35(L)	A2-8	—
	SV	250	φ140 Flat	—
V		40R	A2-8	—
	60R,80R	A2-11	—	
	100R	φ380 Flat	—	
	VTM	70	A2-11	—
	65,100,80YB,120YB	A2-11	—	
※Mounting bolts of LH are unifying specifications. Numerical values in () are large diameter as option.				
KITAKO	ACE		A2-6	—
	HS	4200	A2-6	—
	mini ACE		A2-5	—
	MT4	75,80,80-200,85	φ60 Straight	—
		120,120G,125	A2-5	—
		170,200,250S	A2-6	—
	MT3	120	A2-5	—
		200	A2-6	—
	TG1	52	A2-6	—
	TM1	52	A2-6	—
	V	5II,Turn	A2-6	—
	VT1	200	A2-6	—
	400,500	A2-8	—	
	VT2	500	A2-8	—
VT4	200	A2-6	—	
	350,450,550	A2-8	—	
DANICHIKINZOKU KOGYO	B70		A2-11	—
	DGL	6,8,10	A1-6	—
	DHK,DHM,N105,SH		A1-11	—
	DLG	SH	A1-6	—
		SHB	A1-11	—
	DM		A1-11	—
		III	A2-11	—
	F	15	A2-5	—
		20	A2-6	—
		25	A1-6	—
		30,35	A2-8	—
	M95		A1-11	—
	MC	112,132,152	A2-15	—
	TAL	460,510	A1-6	—
		600	A1-8	—
TC	100	Straight φ140	—	
	200	A2-6orStraightφ140	—	
	350	A2-8	—	
	40	A2-11	—	
TAKIZAWA	TK	2	A2-6	—
	TAC	360	A1-5	—
		510,650	A2-8	—
		780	A2-11	—
		950	A2-11	—
	TSL	550,800	A1-5	—
	TT	160	Straight φ140	—
		200	A2-6	—
	TMM	250	A2-8	A2-6
		200	A2-6	A2-6
TNR	200	A2-6	A2-6	
OHBU KOKI	LLA	800,1000,1500,2000,2500,3000	A2-8	—
	CLL	1000,1500,2000,2500,3000	A2-11	—
TSUGAMI	PAN	1,2	Straight, plate	—
	NCM	45/160,70/160	Straight, plate	—
	NL	1	A1-6	—
NAKAMURA	1H		A1-5	—
	TMC	12	A2-5	—
		18	A2-6	—
	TMY	25	A2-6	—
	SC	150II	A2-5	—
	200	A2-6	—	
	250	A2-8	—	
	300	A1-8	—	
	450	A2-8	—	

Jaws and Accessories

Model		First Spindle Nose (JIS)	Second Spindle Nose (JIS)
NAKAMURA	TW	8	Straight ϕ 108
		10	A2-5
		20	A2-6
		30	A1-8
	WT	100	A2-5
		150	A2-5
		250A	A2-6
		250B	A2-5
		250C	A2-5
		300	A2-6
	STW/STS	40	A1-8
	WTW/WTS	150 Big bore	A2-6 ϕ 65
		150 Big bore	A2-5 ϕ 51
		150A	A2-5 ϕ 42
		150B	A2-5 ϕ 32
	NTX-W	ϕ 61	A2-6
	NTX-S	ϕ 71	A1-8
	NTJ	ϕ 51	A2-5
		ϕ 65	A2-6
	NTM3	ϕ 51	A2-5
NTY3		A2-5	
NTJX	ϕ 51	A2-5	
	ϕ 65	A2-6	
SUPER TURN	2AM	A2-5	
	2BM	A1-8	
	3	A1-6	
	4	A1-8	
	5	A1-8	
	6	A1-11	
CITIZEN MACHINERY	ABX	51SY,51TH2	A2-6
		64SY,64TH2	A2-8
	BNC	34C5,42C5	Straight, plate
	BND	34C5,42C5	Straight, plate
		34S5,42S5	Straight, plate
		51C2	A2-6(Enlarged:A2-8)
		51S2,51SY2	A2-6(Enlarged:A2-8)
	BNE	34S5,34SY5	Straight, plate
		51S,51SY5	A2-6
	BNJ	34S,34SY	Straight, plate
		42S,42SY	Straight, plate
		51S,51SY2	A2-6(Enlarged:A2-8)
	BX	20S,26S	Straight, plate
	LX	06E2	Straight, plate
		08C,08R	Straight, plate
		08E2	A2-6
	LZ	01R2,01RY2	Straight, plate
		02R2,02RY2	A2-6
GN	3200,3000,4	Straight, plate	
	3000W,3100W	Straight, plate	
	BM250	Straight, plate	
MURATA	MW	100G(HG),120G(HG)	A2-5
		200G	A2-6
		200GS	A2-8
		300G	A2-8
		400G	A2-11
	MS	50G,60G	A2-5
		100G	A2-6
	MZ	60G	Flat
	MD	60G	A2-5
		100G	A2-6
		120G	A2-5
		200G	A2-6
	MT	12	A2-5
		20,25	A2-6
	MV	120(M)	A2-5
WSC	6	Straight, plate	
	12	A2-5	
1SC	10M5000	A2-6	
	12M5020	A2-8	
MSC	22	A2-8	
2SC	15M5060,18M5090	A1-11	
3SC	24(M5240),28	A1-15	
DMG MORI SEIKI	CL	1500	A2-5
		2000A,2000B(Large bore spec)	A2-6
	Dura Turn	1530	A2-5
		2030	A2-6
		2050	A2-6
		2550	A2-8
	MT		A2-5
		(Large bore spec)	A2-6
		With 2nd main spindle	A2-5
		With 2nd main spindle(Large bore spec)	A2-6
		2000	A2-6
		2000(With 2nd main spindle)	A2-6
		2500,3000	A2-8
		2500(With 2nd main spindle),3000(With 2nd spindle)	A2-8
		4000A Type	A2-11
		4000B Type	A2-15
		4000C Type	A1-20
		4000A Type(With 2nd main spindle)	A2-11
	4000B Type(With 2nd main spindle)	A2-15	

Model		First Spindle Nose (JIS)	Second Spindle Nose (JIS)	
MT	4000C Type(With 2nd main spindle)	A1-20	A2-8	
NL	1500	A2-5	—	
	1500(With 2nd main spindle)	A2-5	A2-5	
	2000	A2-6	—	
	2000(With 2nd main spindle)	A2-6	A2-5	
	2500,3000	A2-8	—	
NT	2500(With 2nd main spindle)	A2-8	A2-5	
	3100,3150	A2-5	—	
	3100(With 2nd main spindle),3150(With 2nd spindle)	A2-5	A2-5	
	3200,4200	A2-6	—	
	3200(With 2nd main spindle),4200(With 2nd spindle)	A2-6	A2-6	
	4250,4300	A2-8	—	
	4250(With 2nd main spindle),4300(With 2nd spindle)	A2-8	A2-8	
	5400	A2-11	—	
	5400(With 2nd main spindle)	A2-11	A2-11	
	6600B	A2-15	—	
NZ	6600B(With 2nd main spindle)	A2-15	A2-15	
	6600C	A1-20	—	
	6600C(With 2nd main spindle)	A1-20	A1-20	
	1500	A2-5	—	
NZ-S	2000	A2-6	—	
	1500	A2-5	A2-5	
RL	1500(Large bore spec)	A2-6	A2-6	
	153	A2-5	A2-5	
	203	A2-6	A2-6	
SL	2500	A2-8	A2-8	
	154	A2-5	—	
	154(With 2nd main spindle)	A2-5	A2-5	
	204	A2-6	—	
	204(With 2nd main spindle)	A2-6	A2-5	
	2500Y,303A,303B(Large bore spec)	A2-8	—	
	403B,65B,65MC	A2-11	—	
	403C,603B,803A,80A,80F	A2-15	—	
	603C,65C,803,803B,80,80B	A1-20	—	
	65A,75A	A1-11	—	
VL	803C,80C	A2-20	—	
	1000	A2-5	—	
ZL	253A1	A2-8	—	
	553	A2-11	—	
ZT	153	A2-5	—	
	153(With 2nd main spindle)	A2-5	A2-5	
	203,253(High speed spec.)	A2-6	—	
	203(With 2nd main spindle)	A2-6	A2-5	
	253,35	A2-8	—	
	253S	A2-8	A2-5	
ZT	45B,45MC	A2-11	—	
	1000Y,1500Y	A2-5	A2-5	
	1500YB	A2-6	A2-5	
	1500YB(With 2nd main spindle, Large bore spec)	A2-6	A2-6	
MAZAK	2500	A2-8	A2-8	
	S1500	A2-5	—	
	S1500(Large bore spec)	A2-6	—	
	CT	4500	A2-11	
		5500	A2-20	
	DT	20	A2-6	
		25	A2-8	
	INTE	2004S	A2-8	A2-8
		1004	A2-5	—
		1004S	A2-5	A2-5
2004		A2-6	—	
2004S		A2-6	A2-6	
30,044,004		A2-8	—	
3004S,4004S		A2-8	A2-8	
410H2,410H2 Option spec,420H2		A2-8	—	
410HS2,410HS2 Option spec,420HS2		A2-8	A2-8	
420H2 Option spec,500H2,650H2		A2-11	—	
IVS	420HS2 Option spec,500HS2,650HS2	A2-11	A2-11	
	500H2 Option spec,650H2 Option spec	A2-15	—	
	500HS2 Option spec,650HS2 Option spec	A2-15	A2-11	
	200	A2-6	—	
M	300	A2-8	—	
	400	A2-11	—	
	4	A2-8	—	
MP	5	A2-11	—	
	6100	A2-5	A2-5	
	4200,6200	A2-6	A2-6	
	4300,6250,6300,650	A2-8	A2-8	
MPN	8200Y	A2-6	A2-6	
NANO TURN		ϕ 85h6 Flat	—	
PM		A1-11	—	
QTN	100	A2-5	—	
	100S	A2-5	A2-5	
	150,200	A2-6	—	
	200S	A2-6	A2-5	
	250	A2-8	—	
	300	A2-8	—	
	350,400	A2-11	—	
	450	A2-15	—	
ST	450,50	A1-11	—	
	60	A2-15	—	
	80	A2-11	—	



CHUCK

For mounting a short taper chuck to lathe spindle end

●About lathe spindle end

Standards covering the lathe spindle end are stipulated in ISO, ASA, DIN, etc except JIS.

Japan major lathe manufacturers manufacture the great majority of lathe spindle end parts at standards of JIS-A1, A2 (ISO-A1, A2). However, a part of lathe spindle end parts is manufactured at ASA-A1, A2.

Although the spindle end dimensions according to each standard are the same, the dimensional tolerance of a face plate (chuck or back plate) varies by a few microns.

●Mounting the short taper (direct type) chuck for spindle end

The taper diameter of the short taper chuck for the spindle end is small slightly and the chuck has the some amount of interference (tolerance). A little gap occurs in mutual mounting end faces when the chuck is set. The chuck is closely touched by screwing mounting bolts. (The face having mounting bolt holes is the mounting face.) Tighten the chuck evenly by screwing bolts diagonally.

When interference (tolerance) of the chuck is large or small, any gap may occur in diameter direction. In the former case, the chuck may be deformed at the time of chuck mounting. In the latter case, a gripping accuracy becomes low for increasing a mounting error.

Similarly, the scroll chuck will also be deformed by tightening it excessively when mounting the chuck to the small end face of spindle end taper. Thus, the handle operation or chuck motion becomes heavy extremely.

Moreover, take care since the more interference, the more failure becomes large.

※See a lathe matching list of the short taper chuck.

When you need taper correction, since correction expense is required separately, please consult our company.

●For order of separate jaw scroll chucks JN-RA for short taper

When placing an order, establish contact with your agent or our company to advise a manufacturer name and type of a lathe used in a customer shop.

Since the dimensional tolerance of spindle end face may vary by manufacturers, it is necessary to correct the taper of the chuck rear body. (Please understand that there is a fluctuation of a delivery date and a price.)

Moreover, JN-RA types are standard and chuck mounting M bolts are packed together with the chuck. Since each chuck mounting bolt is manufactured at inch (UNIH1 bolt or wit screw) by manufacturers, confer with our company.

Nose shape figure

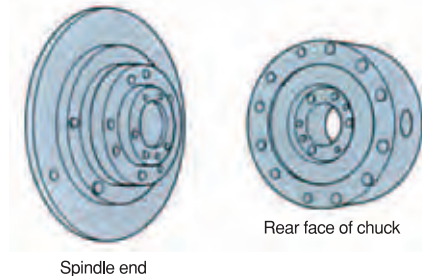

Nose dimension figure



Spindle end and face plate of JIS B 6109 lathe

No.	5-nose	6-nose	8-nose	11-nose	15-nose
A	133	165	210	280	380
B	82.563	106.375	139.719	196.869	285.775
C ₀	104.8	133.4	171.4	235	330.2
C ₁	61.9	82.6	111.1	165.1	247.6
D ₁	14.288	15.875	17.462	19.050	20.638
D ₂	13	14	16	18	19
E	15.88	19.05	23.81	28.58	34.93
G	M10	M12	M16	M20	M22

■Note) D1 is nose A1 and D2 nose A2



CHUCK

For order of Scroll chuck

- For order of hard jaws of scroll chuck [Internal, External & 2 piece jaw (Top and Base jaws)]
 - SC series · · · Bodies of 3, 4, 5, 14 and 16 inches are made of cast iron.
 - JN/JN-T JN-RA series · · · Bodies of 12 -16 inches are made of steel.

In SC series, Hard jaws are ground with the chuck and it is required the tolerance combination on the jaw fitting. As a general rule, Gripping face is ground concentrically in our shop as repair.

In JN series, the tolerance combination is not required but Gripping face is need to be ground concentrically.

In case of Base jaw for the 2 piece jaw chucks(JN-T/JN-RA), the tolerance combination is also required as well as SC type chucks.

At customer's strong demand, only parts will be supplied however, problem may occur, i.e. Accuracy is not satisfied because jaws are not ground with the existing chuck body.

■ Hard Jaw (SC series)

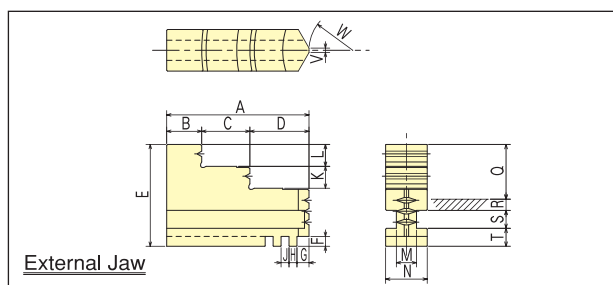
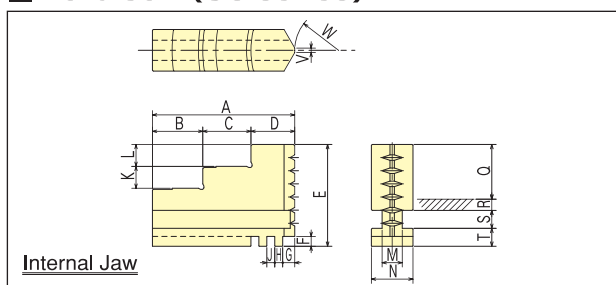

■ SC series Jaw Dimensions

Model		A	B	C	D	E	F	G	H	J	K	L	M	N	Q	R	S	T	V	W
SC-3	Internal jaw	35	14	10	11	29	2.5	4	2.11	2.11	6	6	5.7	11	15	2.75	6.55	4.7	1	R 7.5
	External jaw	35	9	10	16	29	2.5	4	2.11	2.11	6	6	5.7	11	15	2.75	6.55	4.7	1	R 7.5
SC-4	Internal jaw	42	16	13	13	34.5	3.5	4.5	2.54	2.54	7	7	7.2	14	18	3.75	6.55	6.2	1.5	R11
	External jaw	42	10	13	19	34.5	3.5	4.5	2.54	2.54	7	7	7.2	14	18	3.75	6.55	6.2	1.5	R11
SC-5	Internal jaw	50	20	15	15	40	4	4	3.175	3.175	8	8	7.2	16	20	4.1	8.2	7.7	1.5	R15
	External jaw	50	14	15	21	40	4	4	3.175	3.175	8	8	7.2	16	20	4.1	8.2	7.7	1.5	R15
SC-14	Internal jaw	132	49	42	41	93.5	7	8	5.08	5.08	18	18	19	35	52	9.3	16.2	16	5	R47
	External jaw	132	40	41	51	93.5	7	8	5.08	5.08	18	18	19	35	52	9.3	16.2	16	5	R47
SC-16	Internal jaw	146	52	50	44	102	7	10.5	5.08	5.08	20	20	23	40	58	11.8	16.2	16	6	R53
	External jaw	146	43	50	53	102	7	10.5	5.08	5.08	20	20	23	40	58	11.8	16.2	16	6	R53

■ Hard Jaw (JN series)

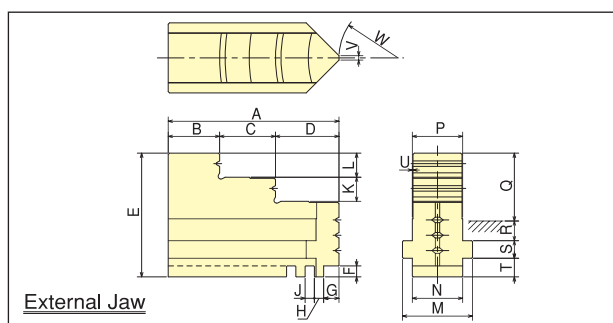
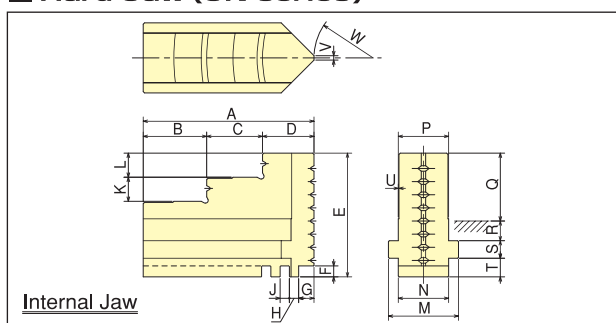

■ JN series Jaw Dimensions

Model		A	B	C	D	E	F	G	H	J	K	L	M	N	P	Q	R	S	T	U	V	W
JN06	Internal jaw	66	26.5	19	20.5	48.5	4.5	5.5	3.629	3.629	9	9	29	21	21	27	8	6.5	7	0.3	2	R19.5
	External jaw	66	18	19	29	48.5	4.5	5.5	3.629	3.629	9	9	29	21	21	27	8	6.5	7	0.3	2	R19.5
JN07	Internal jaw	78	29	25.5	23.5	56.5	5	7	4.233	4.233	11	11	32	23	23	31	9	8	8.5	0.3	2	R27
	External jaw	78	20.5	25.5	32	56.5	5	7	4.233	4.233	11	11	32	23	23	31	9	8	8.5	0.3	2	R27
JN09	Internal jaw	88	34	28	26	62.5	5	7.5	4.233	4.233	13	13	38	27	27	33	10.5	9.5	9.5	0.3	3	R34.5
	External jaw	88	24	28	36	62.5	5	7.5	4.233	4.233	13	13	38	27	27	33	10.5	9.5	9.5	0.3	3	R34.5
JN10	Internal jaw	98	36.5	32	29.5	66.5	5	7.5	4.233	4.233	14	14	38	27	27	37	10.5	9.5	9.5	0.3	3	R42
	External jaw	98	28	32	38	66.5	5	7.5	4.233	4.233	14	14	38	27	27	37	10.5	9.5	9.5	0.3	3	R42
JN12	Internal jaw	113	41.5	36.5	3.5	81	6	8	5.08	5.08	15	15	44	31	31	44	14.5	11	11	0.3	4	R42
	External jaw	113	33	36.5	43.5	81	6	8	5.08	5.08	15	15	44	31	31	44	14.5	11	11	0.3	4	R42

■ Gripping range

Model	Gripping range							
	External gripping					Internal gripping		
	A1	A2	A3	A4	Soft Jaw	B1	B2	Soft Jaw
SC-3 (F)	2~35	33~55	53~70	2~35	(2~70)	24~44	42~64	(24~64)
SC-4 (F)	3~43	41~69	67~95	3~43	(3~95)	29~57	55~84	(29~84)
SC-5 (F)	3~46	44~77	75~110	3~46	(3~110)	33~67	65~100	(33~100)
JN06	3~64	62~112	110~160	3~64	—	48~100	98~150	—
JN06T	3~64	62~112	110~160	—	3~160	55~104	102~150	55~150
JN06R	3~64	62~112	110~160	—	—	55~104	102~150	—
JN07	4~72	70~126	124~180	4~72	—	56~114	112~170	—
JN07T	4~68	66~124	122~180	—	4~180	62~117	115~170	62~170
JN07R	4~68	66~124	122~180	—	—	62~117	115~170	—
JS07	4~72	70~126	124~180	4~72	—	56~114	112~170	—
JT07	—	—	—	—	4~180	—	—	62~170
JN08R	4~76	74~138	136~200	—	—	62~127	125~190	—
JN09	5~84	82~150	150~220	5~84	—	62~137	135~210	—
JN09T	5~80	78~150	148~220	—	5~220	70~141	139~210	70~210
JN09R	5~80	78~150	148~220	—	—	70~141	139~210	—
JS09	5~84	82~152	150~220	5~84	—	62~137	135~210	—
JT09	—	—	—	—	5~220	—	—	70~210
JN10	5~96	94~178	176~260	5~96	—	70~161	159~250	—
JN10T	5~94	92~177	176~260	—	5~260	80~166	164~250	80~250
JN10R	5~94	92~177	176~260	—	—	80~166	164~250	—
JN12	10~108	108~204	202~300	10~108	—	86~189	187~290	—
JN12T	10~108	108~204	202~300	—	10~300	90~191	189~290	90~290
JN12R	10~108	108~204	202~300	—	—	90~191	189~290	—
SC-14	25~118	116~210	208~315	25~118	—	107~188	186~290	—
SC-16	25~132	130~215	213~360	25~132	—	113~212	210~340	—

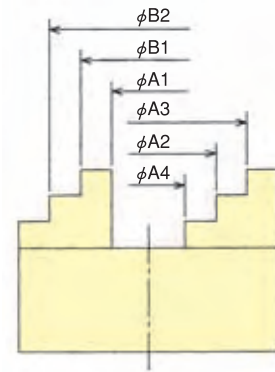

SC (F) / JN / JS type

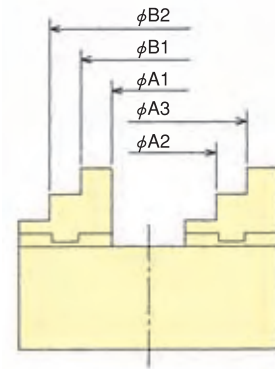

JN-T / JN-R type

■ Chuck handle Dimensions

Model	F1	F2	F3	F4	F5
SC-3	65	15	8	110	7
SC-4	70	17	8	140	8
SC-5	75	20	10	170	8
JN06	120	20	10	210	10
JN07	160	20	12	240	11
JN09	160	22	12	290	12
JN10	160	22	12	360	12
JN12	200	26	16	390	14
SC-14	140	30	16	450	15
SC-16	140	30	16	450	15
IC-4	75	12	8	120	6
IC-6	100	13	8	150	8
IC-8	130	15	10	200	10
IC-10	150	18	12	250	10
IC-12	170	19	12	300	12
IC-14	170	19	12	300	12
IC-16	220	22	16	400	14
IC-18	220	22	16	400	14

